



**Victorian**  
INDEPENDENT FLOORING

# PRODUCT CATALOGUE





Above: Adrian and Nikki

## VICTORIAN INDEPENDENT FLOORING

Victorian Independent Flooring was opened by Adrian and Nikki on the 1st of June 2015. Bringing with them a combined 40 years' experience in the Flooring Industry. VIF is an Australian owned business that will strive to provide family values, quality products and exceptional service.

# CONTENTS

Adhesives	4-5
Levelling, Primers & Barriers	6-7
PVC Skirtings	8
Edge Capping	9
PVC Extrusions	9
Carpet Gripper	10
Carpet Seam Tapes	11
MDF Ramp	11
Knives	12
Blades	13-14
Carpet Tools	15-17
Vinyl Tools	18-19
General Tools	20-23
Floor Preparation Tools	24-25
Staples	26
Tapes	26
Sandpaper	26
Wolff Machine	27
Wolff Tools	28-31
Underlayments & MDF Ramp	32
Floor Protection	32
Tactile Plates	32
Nails	33
Wood Floor Tools	33
<hr/>	
Quality Flooring Transitions	34
Carpet Tile Trims	35
Carpet and Vinyl Trims	36
Reducers, Expansion Joints & Covers	37
Tile Trims	38
Floating Floor Trims	39-40
Stair Nosings	41-42

# ADHESIVES



**U-U500-12**  
Uzin U500  
Pressure Sensitive 12kg



**U-UZ57-14**  
Uzin UZ57  
Carpet Adhesive 14kg



**U-KE16-14**  
Uzin KE16  
Vinyl Adhesive 14kg



**U-KE2000S**  
Uzin KE2000S  
Universal Vinyl/Rubber/  
Linoleum Adhesive.  
Available in 2kg, 6kg & 14kg



**U-KE66-14**  
Uzin KE66  
High Shear Strength  
Vinyl & Rubber 14kg



**U-KE2000SL**  
Uzin KE2000SL  
Conductive Adhesive.  
Available in 1.5kg & 14kg



**U-KE68-14**  
Single Part Hybrid 14kg



**U-KR430**  
Uzin KR430  
2 Part Polyurethane.  
Available in 3kg or 8kg



**U-MK95-16**  
Uzin Mk95  
Timber Adhesive 16kg



**CONT-SKIR**  
VIF Skirting Contact.  
Available in 1L, 4L & 20L



**CONT-SPRA-20**  
VIF Spray Contact 20L



**VSS**  
Vinyl Seam Seal 250ml



**U-WK222-5**  
Uzin WK222  
Solvent Free Contact 5kg



**CSS-1**  
Carpet Seam Sealer 1L



**U-SIG**  
Uzin Sigan 1, 2 or 3



**U-WK222-R**  
Spare Rollers



**LAT**  
Carpet Latex. 1L & 5L



**PVA**  
VIF Crosslink PVA.  
Available in 500ml & 5L



**G-ADH**  
VIF Synthetic Grass  
Adhesive. Available  
in 4L & 20L



**GA-500**  
Gripper Adhesive 500ml



**FS470**  
Flexi Spray Pressure  
Sensitive Aerosol.  
Available in 500ml & 22L



**FS600**  
Flexi Spray 600  
Contact Aerosol.  
Available in 500ml & 22L



# LEVELLING, PRIMERS & BARRIERS



**U-DFILL-20**  
Uzin Deepfill 20kg



**U-NC888**  
Uzin NC888  
Turbo Skim Repair.  
Available in 4.5kg or 9kg



**U-NC182-20**  
Uzin NC182  
Rapid Set Mortar 20kg



**U-NC160-20**  
Uzin NC160  
Levelling Compound 20kg



**U-NC170-20**  
Uzin NC170  
Level Star Premium  
Levelling Compound 20kg



**U-NC172-20**  
Uzin NC172  
Bi Turbo Levelling  
Compound 20kg



**UP-PE520-10**  
Uzin PE520  
Primer & Additive 10kg



**UP-PE280-5**  
Uzin PE280  
Universal Primer 5kg



**UP-200ROLL**  
200mm Primer Roller



**U-L3-27**  
Uzin L3  
Gold Levelling System  
Powder 27kg Kit



**UP-L3-5**  
Uzin L3  
Gold Primer 5kg



**VAP**  
Vaporlock Spray on  
Moisture Barrier 20L.  
Also available as  
Antimicrobial or Repeller.



**UP-PE460-10**  
Uzin PE460  
2 Part Moisture Barrier 10kg



**UP-PE480-10**  
Uzin Pe480  
2 Part Moisture Barrier 10kg



**UP-PLAN**  
Planus Primer. Comes in  
2.5kg or 10kg



**U-RR-185**  
Uzin RR185  
Flexible Sheet  
Membrane 50sqm



# PVC SKIRTINGS



**FE100-BK/DG/BG/LG**  
 100mm Feather Edge Skirting 15m.  
 Available in all colour profiles

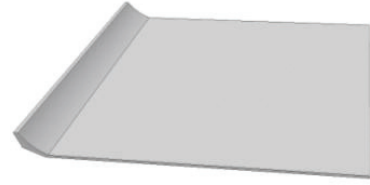

**FE150-BK/DG/BG/LG**  
 150mm Feather Edge Skirting 15m. Available in Beige, Black, Blue, Blue Grey, Dark Grey, Light Grey



**FL100-BK/DG/BG/LG**  
 100mm Flat Skirting 30m. Available in Beige, Black, Blue Grey, Dark grey, Light Grey



**FL150mm-BK**  
 150mm Flat Skirting 30m. Available in Beige, Black, Blue Grey, Dark grey, Light Grey

## COLOUR PROFILES



Beige



Black



Blue



Blue Grey



Dark Grey



Grey



Light Grey



# EDGE CAPPING

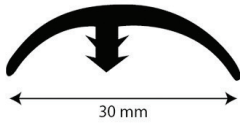

## EC-Edge

Cap 33m. Available in all Colours

## COLOUR PROFILES

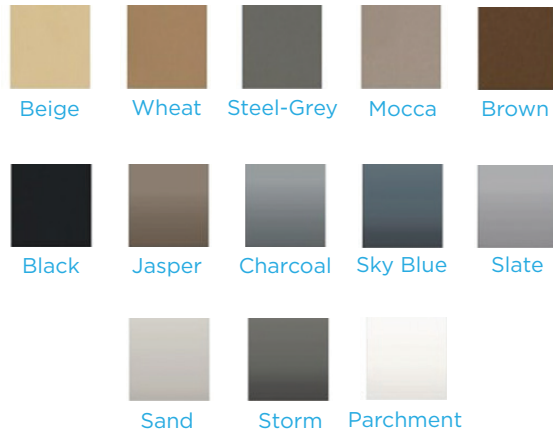

# PVC EXTRUSIONS

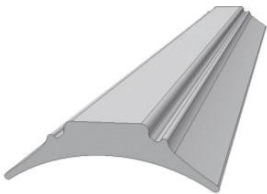

## CF

Cove Filler 15m.  
Available in 20mm or 32mm

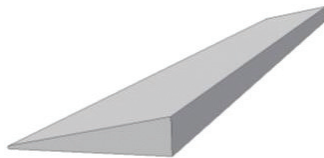

## RTT

PVC Reducer 15m.  
Available in 2mm, 3mm,  
5mm or 8mm



## RAM-2

PVC RAMP 2mm



## RSN-BK

PVC Stairnosing  
Black 2.7m

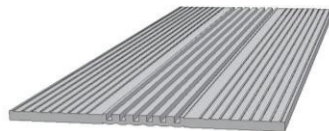

## REXP

PVC Expansion  
Join Cover Black 15m.  
Available in 2mm or 3mm  
and all colour profiles

# CARPET GRIPPER



**GA-500**  
Gripper Adhesive 500ml

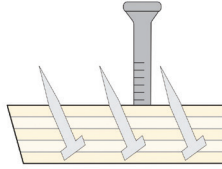

**COM**  
32mm Architectural Carpet Gripper. Available with concrete or wood Nail

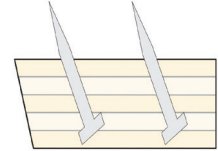

**COM-P**  
32mm Architectural Carpet Gripper, no nail

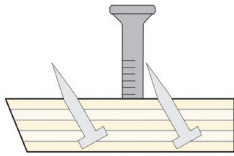

**COM28**  
28mm Budget Carpet Gripper. Available with concrete or wood

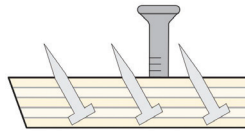

**COMS**  
32mm Architectural Short Pin Carpet Gripper. Available with concrete or wood nails



**Victorian**  
INDEPENDENT FLOORING



**COM VIF Carpet Gripper. Available in:**

- COM-P** Commercial No Nail
- COM-C15** Commercial 15.9mm Concrete
- COM-C17** Commercial 17.8mm Concrete
- COM-W** Commercial Wood
- COM-C17S** Commercial 17.8mm Concrete Short Pin
- COM-WS** Commercial Wood Short Pin

**COM28 Budget Carpet Gripper. Available in:**

- COM28-C17** 28mm Budget Architectural 17mm Concrete
- Com28-CW** 28mm Budget Architectural 17mm Wood

# CARPET SEAM TAPES



**CST-1**  
VIF Heatbond  
Tape 100m



**CST-2**  
Sov Silicon Release  
low Odour 100m



**CST-3**  
Sov Gold Foil  
Tape 100m



**CST-4**  
Sov Low heat wide  
bead 6.5kg glue 100m



**CST-6**  
VIF Dualbond  
Heatbond Tape 100m



**CST-7**  
VIF 6" Wide  
Heatbond Tape 20m



**CST-STEP5**  
Step on Tape 5m

# MDF RAMP



**RE**  
Ramp Edge.  
Available in 5mm or 8mm



**RE-12**  
12mm Ramp Edge.  
Available in 168mm,  
240mm or 300mm wide



**RE-8CNR**  
Ramp Edge 8mm Corners

# KNIVES



**K501**  
Shark Knife



**K501-2**  
2 Notch Shark Knife



**W-KNIFE**  
Wolff Knife



**W-SNKN**  
Wolff Snap off Knife



**K502**  
Magnetic Knife



**K503**  
Dolphin Fixed Knife



**K504**  
Trade Knife



**K505**  
8" Heavy Duty lino Knife



**K506**  
7" Hyde Knife



**K507**  
Red Handled  
Grooving Knife



**K508-1**  
Trimming Knife Guide



**K508-2**  
Trimming Knife Pouch



**K508-A**  
1/4 Moon Knife Angled



**K509**  
Mozart Knife



**K509-1**  
Mozart 0.5mm Guide



**K509-2**  
Mozart 0.7mm guide



**K510**  
Crain Hook Handle Knife



**K508**  
1/4 Moon Trimming Knife

# BLADES



**B900-100**  
Heavy Duty  
Standard Blade 100pk



**B900-M10**  
Mozart Heavy Duty  
Blades 10pk



**B910-100**  
Concave Blades 100pk



**B911-M10**  
Mozart Concave  
Blades 10pk



**B915-M10**  
Mozart Hook Blades 10pk



**B920-M10**  
Sml Hook Blades 10pk



**B925**  
Trimmer Blades. Available  
in a 10pk or 100pk



**B930**  
Slotted Blades. Available in  
a 10pk or 100pk



**B935**  
3 Hole Technical Blade  
10pk



**B940-M10**  
2 Hole Blade 10pk



**B950**  
4" Scrapper Blades.  
Available in a 10pk or 100pk



**B955**  
8" Scrapper Blades 10pk

# BLADES



**B1018**  
Strip Cutter Blades 5pk



**B1405**  
6" H/D Scraper Blades



**BK507-1**  
Sml Round Grooving  
Blades 2pk



**BK507-2**  
Lrg Round Grooving  
Blades 2pk



**BK507-3**  
Flat Grooving Blades 2pk



**BK507-4**  
Diamond Grooving  
Blades 2pk



**B1213**  
Edge Trimmer Blades



**BK509**  
Mozart Knife Blades



**BA11**  
10pk 18mm Snap Off  
Blades



**BA12**  
50pk 18mm Snap Off  
Blades



**W-GCUT-1**  
Wolff Greencut  
Straight Blades 10pk



**W-GCUT-2**  
Wolff Greencut  
Hook Blades 10pk



**W-LINO-1**  
Lino Cut  
Straight Blades 10pk

# CARPET TOOLS



**1001**  
Loop Pile Cutter



**1001-CRAIN**  
Crain Loop Pile Cutter



**1002**  
Red Cutter



**1003**  
Cushion Back Cutter



**1004**  
Wall Trimmer



**1004-1**  
Wall Trimmer Delrin Guide



**1004-CRAIN**  
Crain Wall Trimmer



**1005**  
Sovereign 24 Oz Fibre  
Glass Claw Hammer



**1006**  
Wood Handle Hammer



**1007**  
Carpet Seam Roller



**1007-CRAIN**  
Crain Seam Roller



**1008**  
Deluxe Carpet Seam Roller

# CARPET TOOLS



**1009**  
Duckbill Napping Shears



**1010**  
Sovereign 10" Carpet Shears



**1011**  
Sovereign 12" Carpet Shears

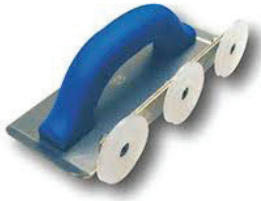

**1012**  
Wall Tucker



**1013**  
Stair Tool



**1013-Crain**  
Crain Stair Tool



**1016**  
Tradesman Choice  
Knee Kicker

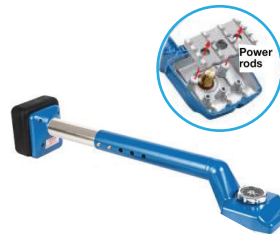

**1016-Crain**  
Knee Kicker



**1016-WCRAIN**  
Crain X-Wide Knee Kicker



**1017-CRAIN**  
Crain Heat Bond Iron



**1017-CRAIN-1**  
Crain Heat bond  
Iron Tool Box



**1018**  
Crain Style Strip Cutter





**1019**  
Hammer Tacker



**1020**  
Base Moulding Lifter



**1021**  
Carpet Claw



**1022**  
Carpet Awl



**1023**  
Carpet Row Finder



**1024**  
Heavy Duty Stand Up Cutter



**1025**  
Carpet Seam Squeezer



**1027**  
GLFC Nail Gun



**1027-1**  
GLFC Nails 15mm & 19mm



**1027-2**  
GLFC Fuel Cells



**1028**  
DIY Wall Trimmer

# VINYL TOOLS



**1200**  
Recess Scriber

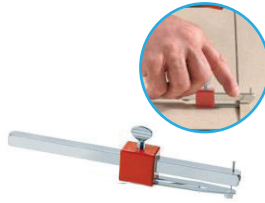

**1200-CRAIN**  
Crain Recess Scriber



**1201**  
Medium Recess Scriber



**1202**  
Bar Scriber



**1202-1**  
Scriber Pins



**1203**  
12" Vinyl Tile Cutter



**1204**  
18" Vinyl Tile Cutter



**1205**  
Round Roller



**1206**  
Square Vinyl Roller



**1209**  
75lb Roller



**1210**  
100lb Roller



**1211**  
Wall Roller



**W-LEI-AT**  
Leister AT  
Digital Weld Gun



**W-LEI-ST**  
Leister ST Weld Gun



**W-LEIS-1**  
Leister Speed  
Welding Nozzle



**W-GONO**  
Wolf Gooseneck Nozzle



**W-BWELD**  
Wolff Broad Welding Tip



**1212-1**  
STD Weld Nozzle



**1212-4**  
5mm Speed  
Welding Nozzle



**W-PURWN**  
PUR Welding Nozzle



**1213-CRAIN**  
Crain Salvage  
Edge Trimmer



**1215**  
Crain Seam Seal Bottle



**1216**  
Triangle Groover



**1217**  
Concave Roller



**1218**  
Convex Roller



**220-CRAIN**  
Crain Vinyl Dolley



**1221-Crain**  
Crain Black Wall Trimmer



**W-EDCU**  
Wolff Edge Cutter



**W-JOGR**  
Wolff Joint Groover

# GENERAL TOOLS



**1400**  
12" Handle 4" Scraper



**1401**  
18" Handle 4" Scraper



**1402**  
48" Handle 4" Scraper



**1403**  
8" Scraper



**1404**  
4" Steel Bar Scraper



**1406-FL**  
12" Flat Trowel



**1406-A1**  
12" A1 Adhesive  
Trowel Trowel



**1406-V1**  
12" V1 Adhesive Trowel



**1406-V2**  
12" V2 Adhesive Trowel



**1406-V3**  
12" V3 Adhesive Trowel



**1407-FL**  
15" Flat Trowel



**1407-V1**  
15" V1 Trowel



**Victorian**  
INDEPENDENT FLOORING

GENERAL TOOLS



**1407-V2**  
15" V2 Trowel



**1407-V3**  
15" V3 Trowel



**1410**  
Sausage Caulking Gun



**1411**  
Sovereign Hacksaw



**1413**  
Multi Angled Shears



**1414**  
24" Tool Box



**1416**  
Nail Drive Bar



**1417-AIR**  
Arco 6000 Series Stapler



**1417-ME4000**  
Maestri ME 4000 Stapler



# GENERAL TOOLS



**1418**  
White Rubber Mallet



**1419-8**  
8m Tradie Tape Measure



**1419-10**  
10m Tradies Tape Measure



**1419-10HD**  
10m Heavy Duty  
Tape Measure

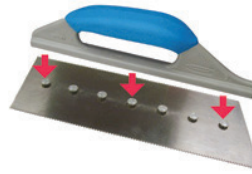

**1421-H1**  
Small Blue Switch  
Blade Handle



**1421-H2**  
Large Red Switch  
Blade Handle



**1421-FL**  
Flat Switch Blade



**1421-U1**  
U1 Switch Blade



**1421-V1**  
V1 Switch Blade



**1421-V2**  
V2 Switch Blade



**1421-V3**  
V3 Switch Blade



**1421-V5**  
V5 Switch Blade

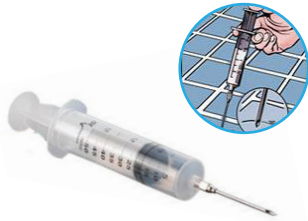

**1422-CRAIN**  
Adhesive Syringe



**1423-CRAIN**  
Crain Tool Pouch



**W-POU**  
Double Knife Pouch



**1429**  
100mm Roller Handle



**1432-CRAIN**  
Crain Rolling Tool Box



**1433**  
Tin Snips



**Knee-3**  
Leather Knee Pads



**KNEE-CRAINBLUE**  
Crain Blue Knee Pads



**KNEE-CRAINS**  
Crain Black Knee Pads



**W-PAN**  
Uzin Trade Pants



**W-PAN**  
Uzin Trade Pants  
Knee Pads



**BRUSH-75**  
75mm Brush

# FLOOR PREPARATION TOOLS



**1602**  
Sovereign  
Gauging Spreaders



**W-GAU**  
Pinned Flat  
Levelling Spreader



**W-RAKE**  
Wolff Levelling Rake



**W-RAKE**  
Wolff Rake  
Replacement Blades



**1603**  
500mm Spiked Roller



**1604**  
700mm Spiked Roller



**W-SROL**  
Wolff Spiked Roller



**1605**  
Levelling Mixing Paddle



**W-STIR**  
Wolff Mixing Paddle



**1606**  
Spiked Shoes



**W-SHOE**  
Wolff Spiked Shoes



**U-MEA**  
Uzin Measuring Bucket





**U-MIX-1**  
Uzin Ripper



**W-MIX1100**  
1 Bag Mixing Drill



**W-MIX1300**  
Heavy Duty  
1300W Mixer



**W-STRH**  
Wolff Standup  
Rake Head



**W-MIXST**  
Wolff Mixing Station



**W-CAD**  
30L Mixing Caddy



**U-MIX**  
Uzin Mixing Bucket



**W-LPIN**  
Wolff Levelling Pins



**W-WMEA**  
Wolff Water Dosing Device

# STAPLES



**4000**  
4000 Series Staples.  
Available in 12mm,  
16mm or 18mm



**6000**  
6000 Series Staples.  
Available in 16mm,  
18mm and 22mm



**A11-8**  
Hammer Tacker  
Staples

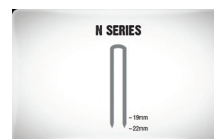

**N22**

# TAPES



**PT48**  
48mm Packing Tape



**MT**  
Masking Tape. Available  
in 36mm & 48mm



**DUCT**  
48mm Silver  
Duct Tape 30m

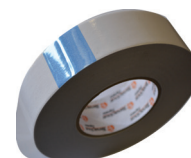

**INS-TAPE**  
Insert Trim Tape 50m.  
Available in 6mm or 40mm.



**DST**  
48mm Double Sided  
Tape. Available in 5m  
or 25m Rolls



**REM-45**  
Remur 45mm Foil  
Skirting Tape 50m



**REM-95**  
Remur 95mm Foil  
Skirting Tape 50m



**SAFE**  
50mm Anti Slip Tape 18m.  
Available Yellow, Black or  
Yellow and Black

# SANDPAPER



**SP405**  
Sanding Discs. Available  
the following Grits 16, 24,  
36, 40, 60, 80, 100, 120



**SP178**  
Edger Disc. Available  
in the following Grits  
16, 24, 36 and 40



**SP305**  
Sanding Disk. Available  
in 24 grit and 40 Grit



**SP12R-40**  
12" 40 Grit 50m Roll

# WOLFF MACHINE



**W-JUNO**  
Wolff Juno Stripper



**W-JUNO**  
Wolff Juno Stripper  
Blades 120mm x 200mm



**W-Duro**  
Wolff Duro Stripper



**W-Duro**  
Wolff Duro Stripper  
Blades STD & Hduty



**W-TURBO**  
Wolff Turbo Stripper



**W-Turbo**  
Wolff Turbo  
Stripping Blades



**W-TURBO**  
U-Shaped Blade 350mm



**W-TURBO**  
Wolff Turbo Weight



**W-Turbo-W**  
Turbo Machine  
Wood Floor Kit



**W-ROBO**  
Wolff Robo Stripper



**W-REBO**  
Wolff Robo  
Stripper Blades



**W-ROBO**  
U-Shaped Blade 410mm

# WOLFF TOOLS



**W-POU**  
Double Knife Pouch



**W-HDSHE**  
Wolff Heavy Duty Shears



**W-RUHA**  
Wolff Rubbing Hammer



**W-SEAM**  
Carpet Seam Roller



**W-NAP7**  
Wolff Napping Shears



**W-SHEA10**  
Wolff 10" Shears



**W-STOOL**  
Wolff Stair Tool 7cm, 9cm



**W-STROL**  
Wolff Stair Tool  
with Roller



**W-CLAW**  
Wolff Claw Tool



**W-RESC**  
Wolff Recess Scriber



**W-WPAL**  
Wolff Wooden Handle  
Palm Spreader



**W-PALM**  
Wolff Palm Spreader



**W-PAN**  
Uzin Trade Pants



**W-PAN**  
Uzin Trade Parts  
Knee Pads



**W-FLX210**  
210cm Flexible  
Straight Edge



**W-FLX410**  
410cm Flexible  
Straight Edge



**W-AFLX-210**  
210cm Anti Slip  
Flexible Straight Edge



**W-FLX210**  
210cm TBAR Flexible  
Straight Edge



**W-FLXT410**  
410cm Tbar Flexible  
Straight Edge



**W-CWMAS**  
Cove Wall Master



**W-SWMAS**  
Straight Wall Master



**W-GCUT**  
Wolff Green Cut



**W-GCUT-1**  
Green Cut  
Straight Blades



**W-GCUT-2**  
Green Cut  
Hook Blades 10pk



**W-LINO**  
Wolff Lino Cut



**W-LINO-1**  
Green Cut  
Straight Blades



**W-KNIFE**  
Wolff Knife



**W-SNKN**  
Wolff Snap Off Knife

# WOLFF TOOLS



**W-TROW**  
Wolff Trowel



**W-TROW**  
Wolff Trowel Blades  
Insert A1, A2, B1 & B11



**W-EDCU**  
Wolff Edge Cutter



**W-ELST**  
Wolff Electric Strip Cutter



**W-JOGR**  
Wolff Joint Groover



**W-LEI-ST**  
Leister ST WELD Gun



**W-LEI-AT**  
Leister AT Digital  
Weld Gun



**W-LEIS-1**  
Leister Speed  
Welding Nozzle



**W-GONO**  
Wolff Gooseneck Nozzle



**W-BWELD**  
Wolff Broad Welding Tip



**W-PURWN**  
PUR Welding Nozzle



**W-SHOE**  
Wolff Spikes Shoes



**W-STRH**  
Wolff Stand Up Rake Head



**W-MIX1600**  
Heavy Duty 1600W Mixer



**W-MIX1000**  
1 Bag Mixing Drill



**W-WMEA**  
Wolff Water Dosing Device



**W-CAD**  
30L Mixing Caddy



**W-MIX-110**  
Wolff 110L Mixing Bucket



**W-MIXST**  
Wolff Mixing Station



**W-SROL**  
Wolff Spiked Roller



**W-LPIN**  
Wolff Leveling Pins



**W-GAU**  
Pinned Flat Levelling Spreader



**W-RAKE**  
Wolff Levelling Rake



**W-RAKe**  
Wolff Replacement Blades



**W-STIR**  
Wolff Mixing Paddle



**W-COP**  
Uzin Copper Strip

# UNDERLAYMENT & MDF RAMP



**HDF**  
HDF EO Underlay



**PLY**  
Ply Underplay 5pk



**VCU**  
Fibre Cement Underlay

# FLOOR PROTECTION

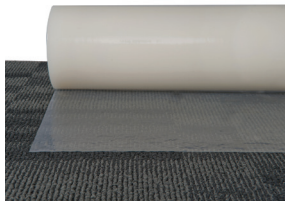

**FP-C100**  
Carpet Floor Protection



**FP-H100**  
Hard Floor Protection



**FP-APL**  
Floor Protection  
Applicator

# TACTILE PLATES

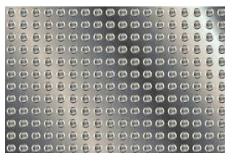

**TAC-PLATE**  
Aluminium Tac Tile Plate  
600 x 900, 600 x 1200,  
600 x 1500

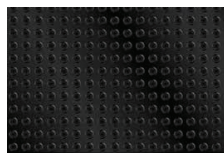

**Black**

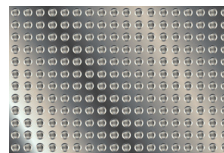

**Mat**



**Yellow**



# NAILS



**Black Concrete Nails**  
1kg. 12mm, 7.8mm, 25mm



**Wood Flooring Nails**  
1kg. 19mm, 25mm



**Ripple Trim Nails**  
1kg. Silver, Gold, Neutral

# WOOD FLOOR TOOLS



**1800-CRAIN**  
CrainHardwood  
Plank Jack



**1801-CRAIN**  
Crain Pry Bar

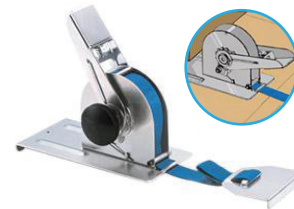

**1805-Crain**  
Crain 18" Strap Clamp



**1806-CRAIN**  
Crain Pry Bar



**W-HDSHE**  
Wolff Heavy Duty Shears



## EXTRUSION, ANODISING AND POWDER COAT STANDARDS

All aluminium sections are extruded to AS 1866-1997, anodized to GB 5237.2:2008 or powder coated to GB 5237.5:2008.

## DETERMINATION OF BURNING BEHAVIOUR USING A RADIANT HEAT SOURCE

### Mean Critical Radiant Flux (MCRF) tested to AS 9239.1.2003

BCA C1.10 2012, Table 2 lists the maximum CRF for Floor Covering Materials in different building types, (with and without a E1.5 sprinklers) and in Fire-Isolated Exits and Fire Control Rooms. BBS aluminium sections show CRF of 12.9kW/m<sup>2</sup>. BBS Luminous Contrasting Strips show a CRF of 8kW/m<sup>2</sup>.

**Both measures meet the standard in all building types.**

### Mean Smoke Development Rate (MSDR) tested to AS 9239.1.2003

BCA C1.10 2012, 3 (b) determines a maximum MSDR of 750%-minutes in buildings not protected by a E1.5 sprinkler. BBS aluminium sections show a MSDR of 2%-minutes. BBS Luminous Contrasting Strips show a MSDR of 410%-minutes. **Both measures meet the standard in all building types.**

**Refer to BCA C1.10 2012 for detailed requirements.**

## ACCESS AND MOBILITY STANDARDS

Mobility and Access Standards for stairnosings and transition strips in a continuous accessible path of travel are governed by **AS 1428.1:2009, Design for Access and Mobility.**

**Refer to these standards for detailed requirements.**

**The Disabilities (Access to Premise-Buildings) Stds Act of 2010** references AS 1428.1:2009 and names the types of buildings, persons and actions to which the Standards apply.

## SLIP RATINGS

### AS 4586:2013, Slip Resistance Classification of New Pedestrian Surface

Materials governs slip ratings for pedestrian surfaces.

**SA HB 198:2014** defines the tests for Floorcovering Materials:

- Wet Pendulum Test (App. A) in most locations (P0-P5).
- Oil-Wet Inclining Platform (App. D) for oil contaminated areas (R9-R13).

**The minimum classifications deemed-to-satisfy building applications in the National Construction Code are:**

APPLICATION	DRY CONDITIONS	WET CONDITIONS
Ramp steeper than 1:14	P4 or R11	P5 or R12
Ramp steeper than 1:20 but not steeper than 1:14	P3 or R10	P4 or R11
Tread or landing surface	P3 or R10	P4 or R11
Nosing or landing edge strip	P3	P4

**The minimum classifications for applications where the National Construction Code does not stipulate Slip Resistance are considered to be:**

LOCATION	WET PENDULUM	OIL-WET INCLINING PLATFORM
<b>External Pavements and Ramps</b>		
External ramps including sloping driveways, footpaths etc. steeper than 1:14	P5	R12
External ramps including sloping driveways, footpaths etc., under 1:14	P4	R11
External sales areas, carparks, colonnades, walkways, pedestrian crossings	P4	R11
External balconies, verandas, carports, driveways, courtyards and roof decks	P4	R11
Undercover car parks	P3	R10

### Hotels, Offices, Public Buildings, Schools and Kindergartens

Entries to hotels, offices, public buildings, schools, kindergartens, common areas of public buildings, internal lift lobbies:

### LOCATION

LOCATION	WET PENDULUM	OIL-WET INCLINING PLATFORM
Wet Area	P3	R10
Transitional Area	P2	R9
Dry Area	P1	R9
Toilet Facilities in offices, hotels and shopping centres	P3	R10
Hotel apartment bathrooms, ensuites and toilets	P2	A
Hotel apartment kitchens and laundries	P2	R9

### Supermarkets and Shopping Centres

Fast food outlets, buffet food servery areas, food courts etc.	P3	R10
Shop and supermarket fresh fruit and vegetable areas	P3	R10
Shop entry areas with external entrances	P3	R10
Supermarket aisles (except fresh fruit areas)	P1	R9
Other separate shops inside shopping centres - wet	P3	R10
Other separate shops inside shopping centres - dry	P1	R9

### Loading docks, Commercial Kitchens, Cold Stores, Serving areas

Loading docks undercover and commercial kitchens	P5	R12
Serving areas behind bars in public hotels and clubs, cold stores and freezers	P4	R11

### Swimming pools and Sporting Facilities

Swimming pool ramps and stairs leading to water	P5	C
Swimming pool surrounds and communal shower rooms	P4	B
Communal changing rooms	P3	A
Undercover concourse areas of sports stadiums	P3	R10

### Hospitals and Aged Care Facilities

Bathrooms and ensuites in hospitals and aged care facilities	P3	B
Wards and corridors in hospital and aged care facilities	P2	R9

**Refer to AS 4586:2014 and its amendments for detailed requirements.**



## CARPET TILE NOSINGS

### #104, 5mm Reducing Strip

AS 1428 Compliant



6mm  
carpet  
tile

### #387, Carpet Tile Vertical Finish

8mm end

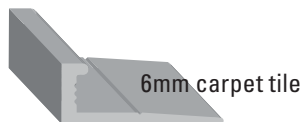

6mm carpet  
tile

### #388, Carpet Tile Straight Ramp

AS 1428 Compliant

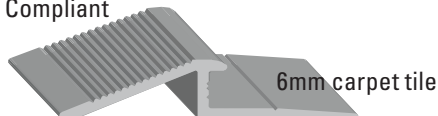

6mm carpet  
tile

### #384, 35mm Carpet Ramp (C/S)

AS 1428 Compliant



6mm carpet  
tile

### #385, Carpet Tile Edge

AS 1428 Compliant



6mm carpet  
tile

### #386, Carpet Tile Vinyl Edge

AS 1428 Compliant



6mm carpet  
tile

2mm vinyl

### #232, 5mm Tile to Vinyl Ramp

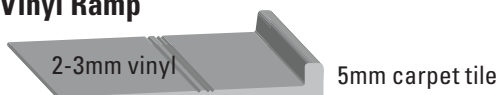

2-3mm vinyl

5mm carpet  
tile



### #202, Carpet Tile Insert Nosing (C/S)

AS 1428 Compliant

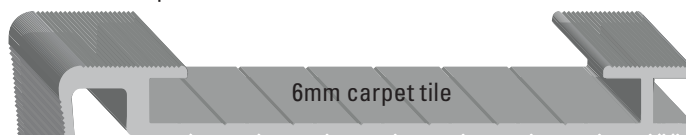

### #226, Commercial Carpet Tile Nosing (C)



### #204, Carpet Tile Nosing (C/S)

AS 1428 Compliant

6mm carpet  
tile

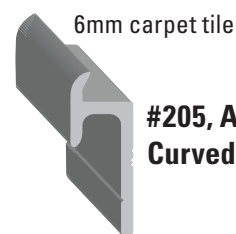

### #205, Auditorium Curved Edge

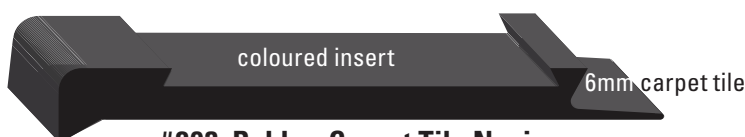

### #203, Rubber Carpet Tile Nosing

AS 1428 Compliant

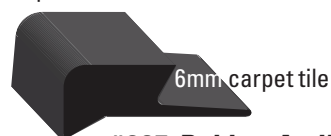

### #207, Rubber Auditorium Edge

C = Countersunk S = Screws & Plugs

## SPECIFICATIONS

	LENGTH	LM/CTN	STOCK COLOURS	AS1428.1
#104, 5mm Reducing Strip	3.66	36.6	○ Mat Silver	Compliant
#202, Carpet Tile Insert Nosing (C/S)	3.66	36.6	○ Mat Silver	Compliant
#203, Rubber Carpet Tile Nosing	3.66	36.6	● Black Rubber	Compliant
#204, Carpet Tile Nosing (C/S)	3.66	36.6	○ Mat Silver	Compliant
#205, Auditorium Curved Edge	3.66	36.6	○ Mat Silver	N/A
#207, Rubber Auditorium Edge	3.66	36.6	● Black Rubber	N/A
#226, Commercial Carpet Tile Nosing (C)	3.66	36.6	○ Mat Silver	-
#232, 5mm Tile to Vinyl Ramp	3.66	36.6	○ Mat Silver	N/A
#384, 35mm Carpet Ramp (C/S)	3.66	36.6	○ Mat Silver	Compliant
#385, Carpet Tile Edge	3.66	36.6	○ Mat Silver	Compliant
#386, Carpet Tile Vinyl Edge	3.66	36.6	○ Mat Silver	Compliant
#387, Carpet Tile Vertical Finish	3.66	36.6	○ Mill Finish	N/A
#388, Carpet Tile Straight Ramp	3.66	36.6	○ Mat Silver	Compliant



## DOMESTIC COVERSTRIPS



**#112, 25mm RippleTrim Junior (P)**  
AS 1428 Compliant



**#156, 30mm RippleTrim (P)**



**#400, 33mm RippleBar (P)**

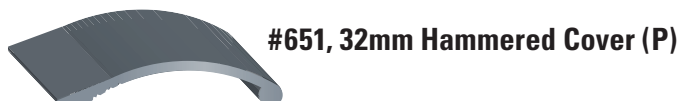

**#651, 32mm Hammered Cover (P)**

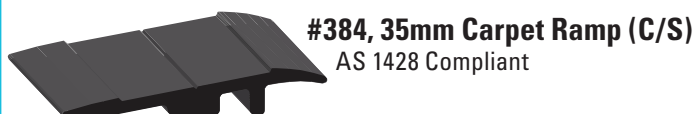

**#384, 35mm Carpet Ramp (C/S)**  
AS 1428 Compliant



**#800, 38mm Commercial Cover (P)**  
AS 1428 Compliant

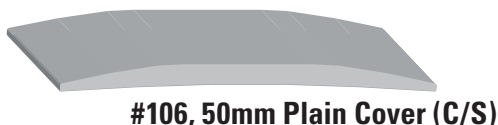

**#106, 50mm Plain Cover (C/S)**

	LENGTH	LM/CTN	STOCK COLOURS
#112, 25mm RippleTrim Junior (P)	3.31	33.1	(Made to order)
#156, 30mm RippleTrim (P)	3.31	33.1	○ ● ● ● ●
#400, 33mm RippleBar (P)	3.31	33.1	○ ● ● ● ●
#651, 32mm Hammered Cover (P)	3.31	33.1	○ ● ● ● ●
#384, 35mm Carpet Ramp (C/S)	3.66	36.6	○ Mat Silver
#800, 38mm Commercial Cover (P)	3.66	36.6	○ Mill Finish
#106, 50mm Plain Cover (C/S)	3.66	36.6	○ Mat Silver

P = Punched, C = Countersunk, S = Screws & Plugs

## ALUMINIUM GRIPPERS



**#722, Bowling Green**



**#723, Double Bond**

	LENGTH	LM/CTN	STOCK COLOURS
#722, Bowling Green	2.5	50	○ Mill Finish
#723, Double Bond	2.5	50	○ Mill Finish

## NAPLOKS

**#150, Domestic Naplok (pinless)**

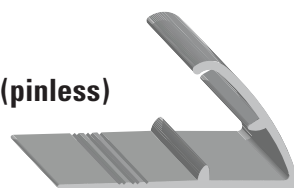

**#803, Domestic Naplok (pinned)**

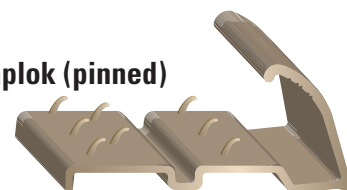

**#111, Commercial Naplok (pinless)**



**#201, Commercial Naplok (pinned)**

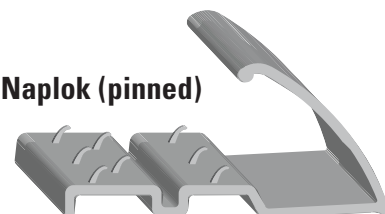

	LENGTH	LM/CTN	STOCK COLOURS
#150, Domestic Naplok (pinless)	3.31	33.1	○ Mill Finish
#803, Domestic Naplok (pinned)	3.31	33.1	○ ● ● ● ●
#111, Commercial Naplok (pinless)	3.66	36.6	○ Mill Finish
#201, Commercial Naplok (pinned)	3.66	36.6	○ Mill Finish

## MULTIPURPOSE TRIMS

**#109, Multi Purpose Extension**

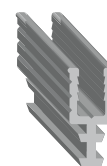

**#108, Multi-Trim (pinless)**



**#908, Multi-Base (pinned)**

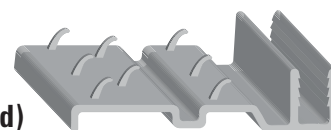

	LENGTH	LM/CTN	STOCK COLOURS
#109, Multi Purpose Extension	3.31	33.1	○ Mill Finish
#108, Multi-Trim (pinless)	3.31	66.2	○ Mill Finish
#908, Multi-Base (pinned)	3.31	66.2	○ Mill Finish



# Reducers, Expansion Joints & Covers

## REDUCERS

**#103, 2mm Reducing Strip**  
AS 1428 Compliant



**#101, 3mm Reducing Strip**  
AS 1428 Compliant



**#104, 5mm Reducing Strip**  
AS 1428 Compliant



## COMMERCIAL COVER

**#106, 50mm Cover (C/S)**



**#107, 80mm Fluted Cover (C/S)**



**#950, Control Joint Tile Edge (C)**



**#930, Control Joint Ramp (C)**



C = Countersunk / S = Screws and Plugs

## EXPANSION JOINTS

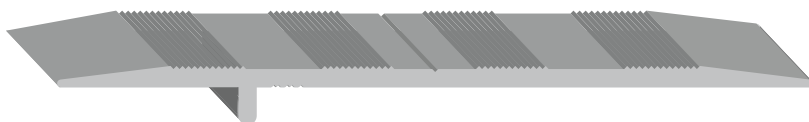

**#105, Construction Joint Cover**



**#128, Aluminium Expansion Joint Set (C/S)**

Both products pass Load Testing to AS/NZS 1170.1-2002 for both distributed and concentrated loads for class D shopping centres.

C = Countersunk / S = Screws and Plugs

## SPECIFICATIONS

	LENGTH	LM/CTN	STOCK COLOURS	SLIP RATING	AS1428.1
#101, 3mm Reducing Strip	3.66	36.6	○ Mat Silver	–	Compliant
#103, 2mm Reducing Strip	3.66	36.6	○ Mat Silver	–	Compliant
#104, 5mm Reducing Strip	3.66	36.6	○ Mat Silver	–	Compliant
#105, Construction Joint Cover	3.66	36.6	○ Mat Silver	P3	Compliant
#106, 50mm Cover (C/S)	3.66	36.6	○ Mat Silver	–	Compliant
#107, 80mm Fluted Cover (C/S)	3.66	36.6	○ Mat Silver	P3	Compliant
#128, Aluminium Expansion Joint Set (C/S)	3.66	36.6	○ Mat Silver	–	Compliant
#930, Control Joint Ramp (C)	3.66	36.6	○ Mat Silver	P3	Compliant
#950, Control Joint Tile Edge (C)	3.66	36.6	○ Mat Silver	P3	Compliant



**STRAIGHT TILE TRIMS**

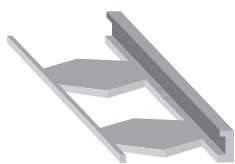

**#040, 4.5mm Tile Angle**



**#042, 6.0mm Tile Angle**



**#044, 8.0mm Tile Angle**

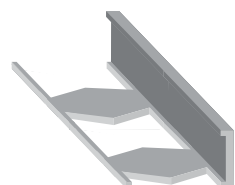

**#046, 10.0mm Tile Angle**

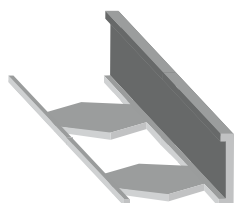

**#048, 12.5mm Tile Angle**

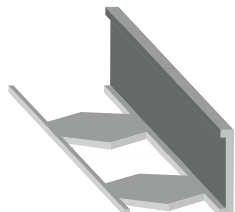

**#050, 15mm Tile Angle**



**FLEXIBLE TILE TRIMS**

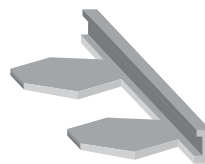

**#040F, 4.5mm Flex Angle**

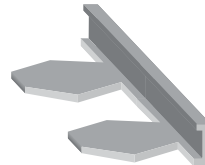

**#042F, 6.0mm Flex Angle**

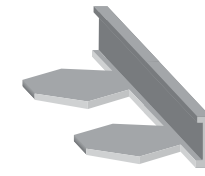

**#044F, 8.0mm Flex Angle**

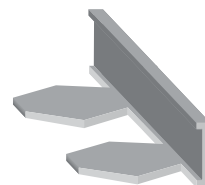

**#046F, 10.0mm Flex Angle**

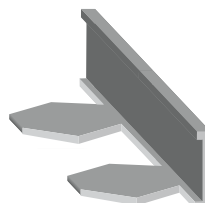

**#048F, 12.5mm Flex Angle**

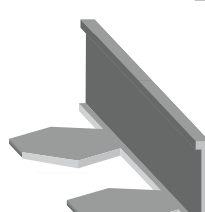

**#050F, 15mm Flex Angle**

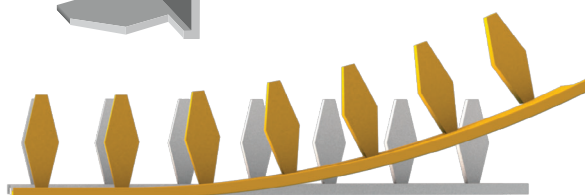

**SPECIFICATIONS**

	LENGTH	LM/CTN	STOCK COLOURS
#040, 4.5mm Tile Angle	3.0	60.0	○ Mill Finish
#042, 6.0mm Tile Angle	3.0	60.0	○ Mill Finish
#044, 8.0mm Tile Angle	3.0	60.0	○ Mill Finish
#046, 10.0mm Tile Angle	3.0	60.0	○ Mill Finish
#048, 12.5mm Tile Angle	3.0	60.0	○ Mill Finish
#050, 15mm Tile Angle	3.0	60.0	(Made to order)
#040F, 4.5mm Flex Angle	3.0	60.0	(Made to order)
#042F, 6.0mm Flex Angle	3.0	60.0	(Made to order)
#044F, 8.0mm Flex Angle	3.0	60.0	(Made to order)
#046F, 10.0mm Flex Angle	3.0	60.0	○ Mill Finish
#048F, 12.5mm Flex Angle	3.0	60.0	○ Mill Finish
#050F, 15mm Flex Angle	3.0	60.0	(Made to order)



## ENDS

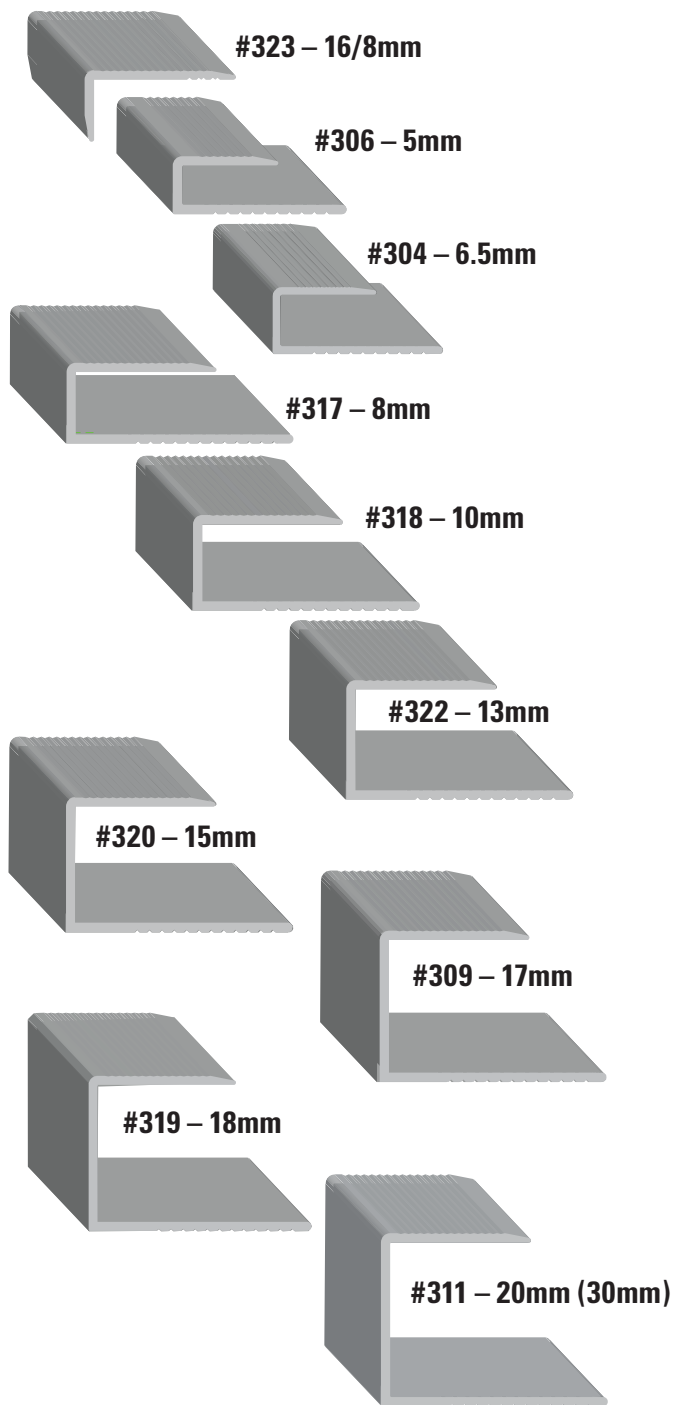

	LENGTH	LM/CTN	STOCK COLOURS
#323, 16 / 8mm Angle End	3.3	33	○ ● ● ● ●
#306, 5mm End	3.3	33	○ ● ● ● ●
#304, 6.5 End	3.3	33	○ ● ● ● ●
#317, 8mm End	3.3	33	○ ● ● ● ●
#318, 10mm End	3.3	33	○ ● ● ● ●
#322, 13mm End	3.3	33	○ ● ● ● ●
#320, 15mm End	3.3	33	○ ● ● ● ●
#309, 17mm End	3.3	33	●
#319, 18mm End	3.3	33	(Made to order)
#311, 20mm End	3.3	33	●

## RAMPS

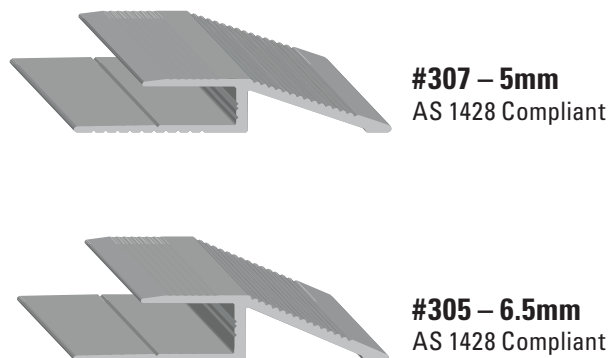

	LENGTH	LM/CTN	STOCK COLOURS	AS1428.1
#307, 5mm Ramp	3.3	33	○ ● ● ● ●	Compliant
#305, 6.5mm Ramp	3.3	33	○ ● ● ● ●	Compliant

## DOUBLE EXPANSIONS

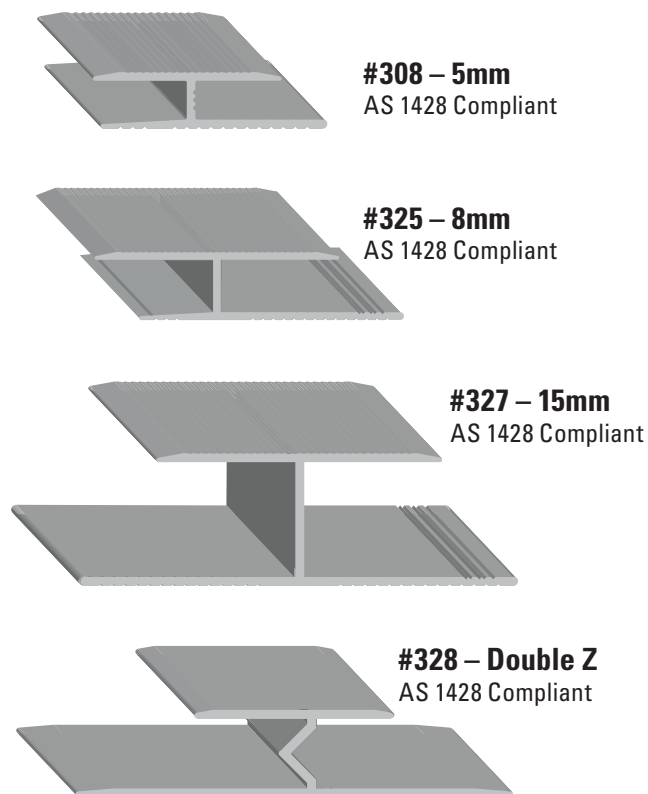

	LENGTH	LM/CTN	STOCK COLOURS	AS1428.1
#308, 5mm Double Expansion	3.3	33	(Made to order)	Compliant
#325, 8mm Double Expansion	3.3	33	(Made to order)	Compliant
#327, 15mm Double Expansion	3.3	33	(Made to order)	Compliant
#328, Double Z	3.66	36.6	○ ● ●	Compliant



## EZI-CLIP

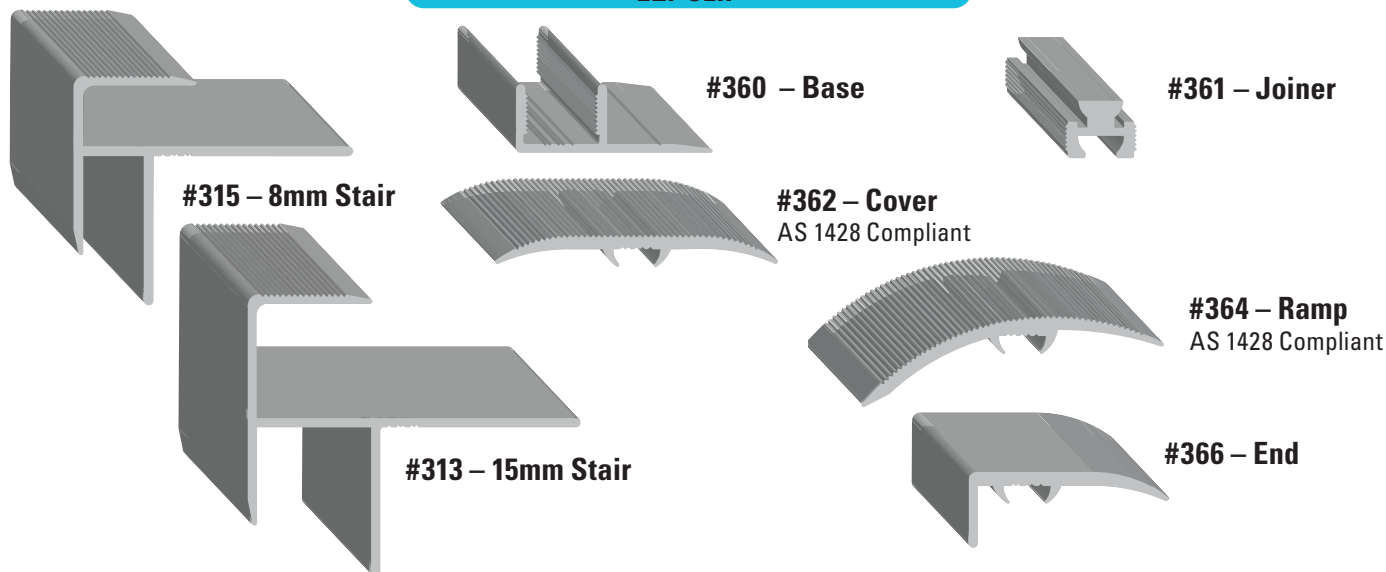

	LENGTH	LM/CTN	STOCK COLOURS	SLIP RATING	AS 1428.1
#315, 8mm Ezi-Clip™ Stair	3.30	33	○ ● ● ●	P4	–
#313, 15mm Ezi-Clip™ Stair	3.30	33	○ ● ● ●	P4	–
#360, 8-13mm Ezi-Clip™ Base	3.30	33	○ Mill Finish	N/A	N/A
#361, Ezi-Clip™ PVC Joiner	3.30	33	N/A	N/A	N/A
#362, Ezi-Clip™ Cover	3.30	33	○ ● ● ●	P4	Compliant
#364, Ezi-Clip™ Ramp	3.30	33	○ ● ● ●	P4	Compliant
#366, Ezi-Clip™ End	3.30	33	○ ● ● ●	N/A	N/A

## AS 1428.1 COMPLIANT STAIR NOSINGS

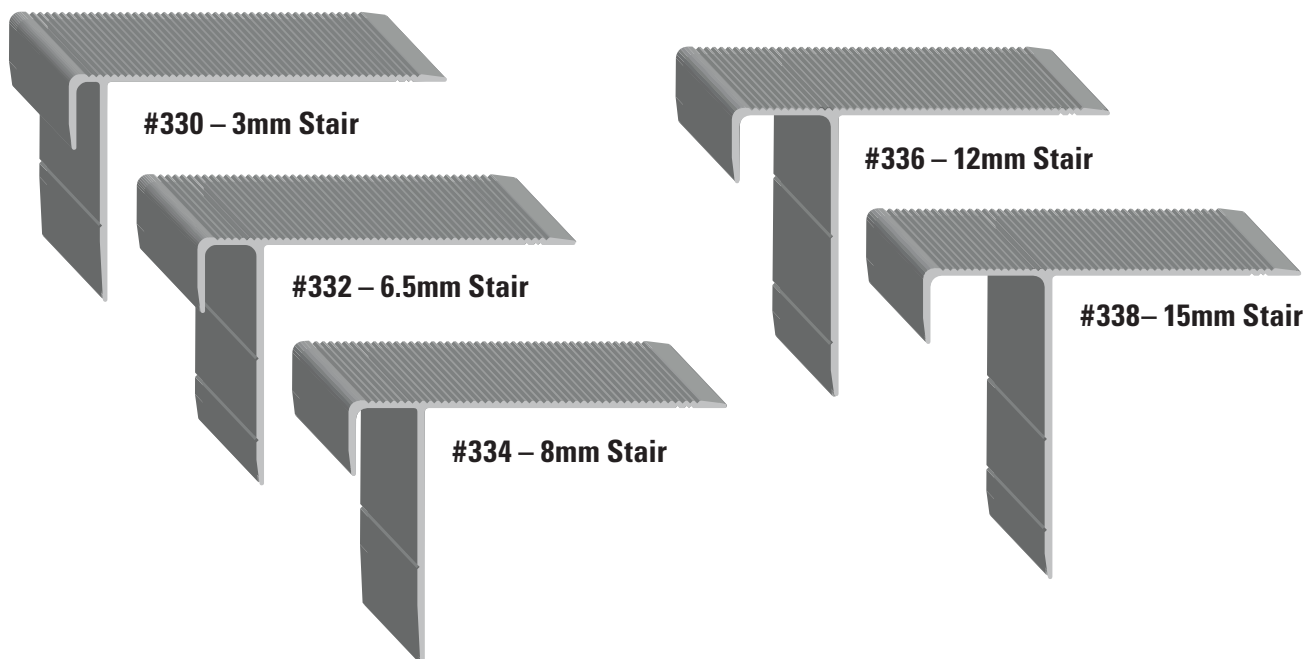

	LENGTH	LM/CTN	STOCK COLOURS	SLIP RATING	AS 1428
#330, 3mm Stair	3.3	33	○ ● ● ●	P4	Compliant
#332, 6.5mm Stair	3.3	33	○ ● ● ●	P4	Compliant
#334, 8mm Stair	3.3	33	○ ● ● ●	P4	Compliant
#336, 12mm Stair	3.3	33	○ ● ● ●	P4	Compliant
#338, 15mm Stair	3.3	33	○ ● ● ●	P4	Compliant





## INSERT NOSINGS

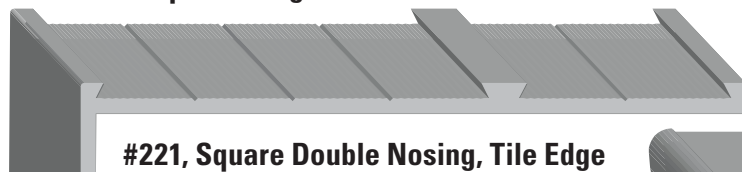
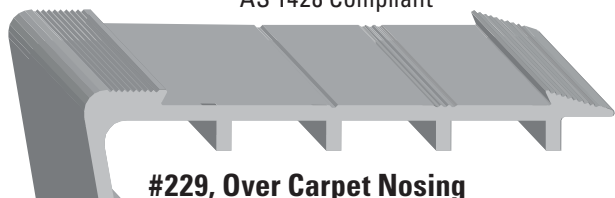
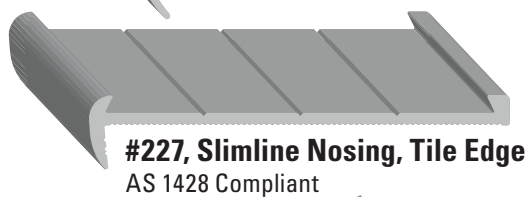
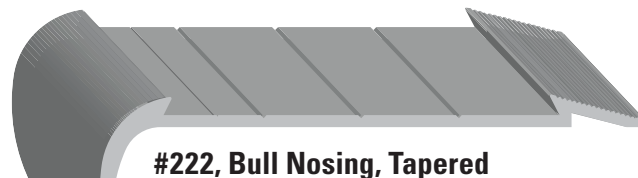
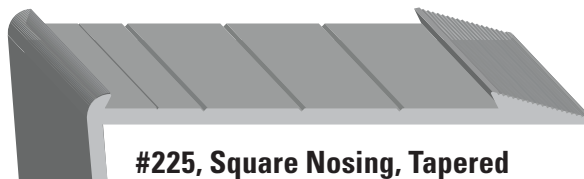
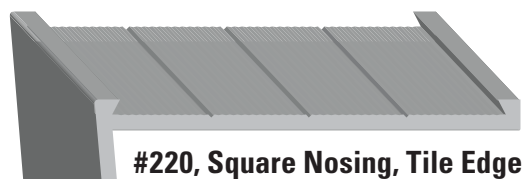

	LENGTH	LM/CTN	STOCK COLOURS	SLIP RATING	AS 1428.1
#220, Square Nosing, Tile Edge	3.66	36.6	○ Mat Silver	P3/ R10	–
#225, Square Nosing, Tapered	3.66	36.6	○ Mat Silver	P3/ R10	–
#223, Bull Nosing, Tile Edge	3.66	36.6	○ Mat Silver	P3/ R10	–
#222, Bull Nosing, Tapered	3.66	36.6	○ Mat Silver	P3/ R10	–
#227, Slimline Nosing, Tile Edge	3.66	36.6	○ Mat Silver	P3/ R10	Compliant
#228, Slimline Nosing, Tapered	3.66	36.6	○ Mat Silver	P3/ R10	Compliant
#229, Over Carpet Nosing	3.66	36.6	○ Mat Silver	P3/ R10	–
#206, Carpet Nosing	3.66	36.6	○ Mat Silver	P3/ R10	Compliant
#221, Square Double Nosing, Tile Edge	3.66	36.6	○ Mat Silver	P3/ R10	–
#208, Carborundum Nosing	3.66	36.6	○ Mat Silver	P5/ R13	Compliant

## RUBBER INSERTS



	LENGTH	LM/CTN	SLIP RATING	AS1428 LUMINANCE REFLECTANCE VALUE	
				DRY	WET
#050B, 50mm Rubber Insert ●	37	(2) 74	P3/R10	3.71	3.51
#050G, 50mm Rubber Insert ●	37	(2) 74	P3/R10	14.31	14.26
#050SY, 50mm Rubber Insert ●	37	(2) 74	P3/R10	43.57	42.12
#025B, 25mm Rubber Insert ●	37	(2) 74	P3/R10	3.71	3.51
#025G, 25mm Rubber Insert ●	37	(2) 74	P3/R10	14.31	14.26
#025SY, 25mm Rubber Insert ●	37	(2) 74	P3/R10	43.57	42.12
#350B, 50mm Grit Tape ●	20	(18) 360	P5/R13	3.21	2.53
#350SY, 50mm Grit Tape ●	20	(18) 360	P5/R13	46.11	45.93



**ORDINARY NOSINGS**



**#917, Hammered Nosing**



**#505, Sawtooth Nosing**

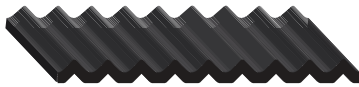

**#600, Stair Tred**  
AS 1428 Compliant

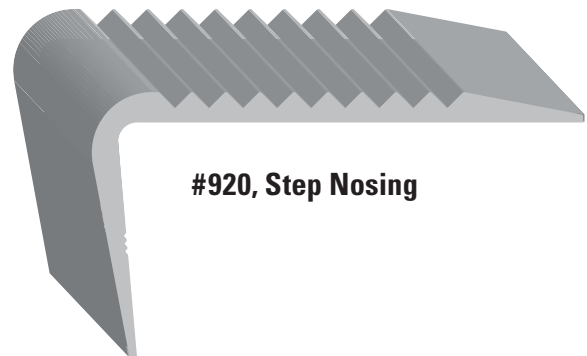

**#920, Step Nosing**

	LENGTH	LM/CTN	STOCK COLOURS	SLIP RATING	AS 1428.1
#917, Hammered Nosing	3.31	33.1	○ ● ● ● ●	P1	–
#505, Sawtooth Nosing	3.66	36.6	○ Mill Finish	P4	–
#600, Stair Tred	3.66	36.6	○ ●	P4	Compliant
#920, Step Nosing	3.66	36.6	○ Mill Finish	P4	–

**ALUMINIUM SKIRTINGS**

**#100, 100mm Aluminium Skirting**



**#150, 150mm Aluminium Skirting**



	LENGTH	LM/CTN	STOCK COLOURS
#100, 100mm Aluminium Skirting	4.0	40	○ Mat Silver
#150, 150mm Aluminium Skirting	3.6	36	○ Mat Silver





**Victorian**  
INDEPENDENT FLOORING

📍 Unit 1, 116-118 Abbott Rd, Hallam, Vic, 3803

☎ 03 9558-9978

✉ sales@vif.net.au

🌐 www.vif.net.au